

Object lamps

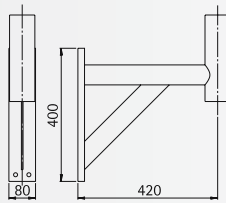

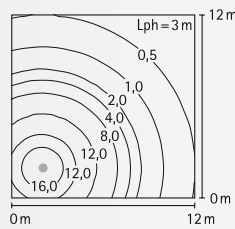

..1008

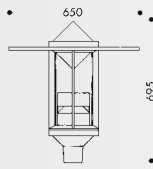

..0816

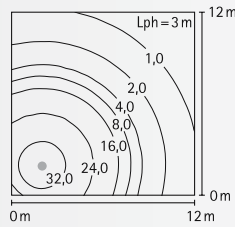

..0817

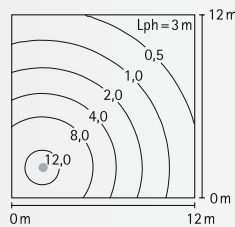
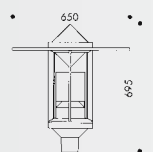

..0822

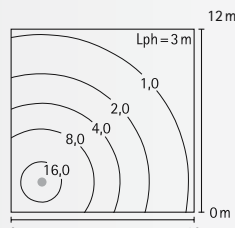

..0825

Pole top lamps

Protection class IP 54
for metal halide lamps HIT-CE, high pressure discharged lamps HME/HSE or for fluorescent lamps TC-L
for pole top $\phi = 76$ mm, pole type A or for installation with the bracket ..1008
cast aluminium, reflector made of anodised pure aluminium
clear impact resistant plexiglass

- Available on request for further lamps

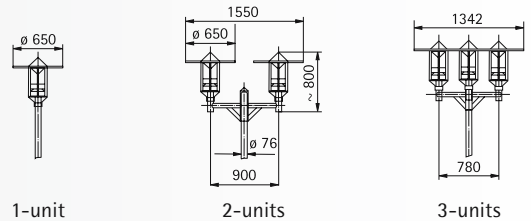

- plane roof with apex

Art.-no.	Lamp	Base	Colour
for metal halide lamps			
1-unit			
660816	1 x HIT-CE 70 W	G12	black
660817	1 x HIT-CE 150 W	G12	black
2-units			
660818	2 x HIT-CE 70 W	G12	black
660819	2 x HIT-CE 150 W	G12	black
3-units			
660820	3 x HIT-CE 70 W	G12	black
660821	3 x HIT-CE 150 W	G12	black

- plane roof with apex

Art.-no.	Lamp	Base	Colour
for high pressure discharged lamps			
1-unit			
660822	1 x HME 80/125 W	E27	black
660824	1 x HSE-E 70 W	E27	black
660825	1 x HSE 100 W	E40	black
2-units			
660826	2 x HME 80/125 W	E27	black
660828	2 x HSE-E 70 W	E27	black
660829	2 x HSE 100 W	E40	black
3-units			
660830	3 x HME 80/125 W	E27	black
660832	3 x HSE-E 70 W	E27	black
660833	3 x HSE 100 W	E40	black



■ plane roof with apex

Art.-no.	Lamp	Base	Colour
for fluorescent lamps TC-L			
1-unit			
660834	2 x TC-L 24 W	2G11	black
2-units			
660835	4 x TC-L 24 W	2G11	black
3-units			
660836	6 x TC-L 24 W	2G11	black

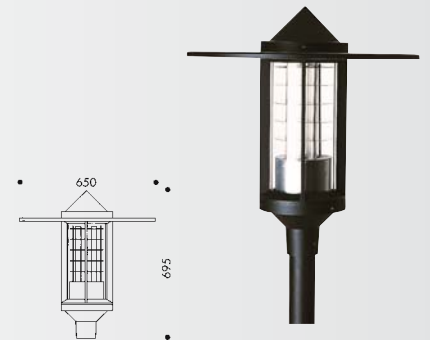
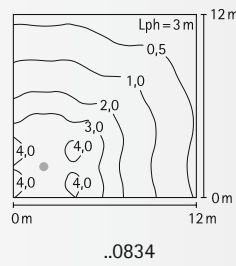

■ plane roof with upper light output

Art.-no.	Lamp	Base	Colour
for fluorescent lamps TC-L			
1-unit			
660840	2 x TC-L 24 W	2G11	black
2-units			
660841	4 x TC-L 24 W	2G11	black
3-units			
660842	6 x TC-L 24 W	2G11	black

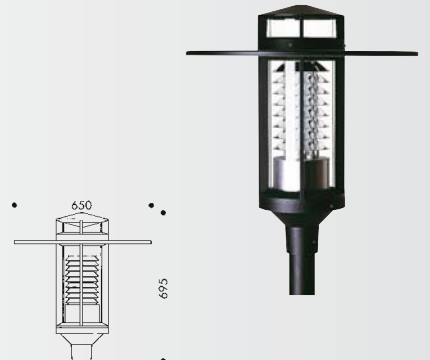
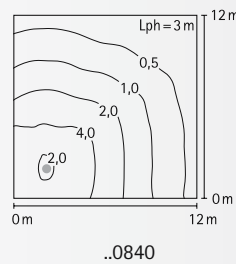

■ plane roof with flat apex

Art.-no.	Lamp	Base	Colour
for fluorescent lamps TC-L			
1-unit			
660837	2 x TC-L 24 W	2G11	black
2-units			
660838	4 x TC-L 24 W	2G11	black
3-units			
660839	6 x TC-L 24 W	2G11	black

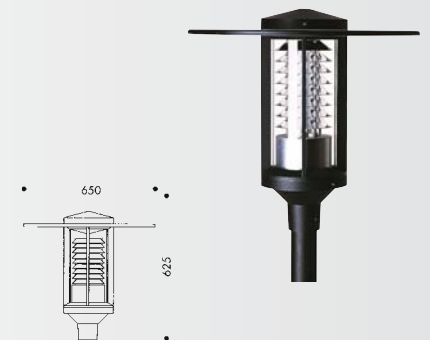
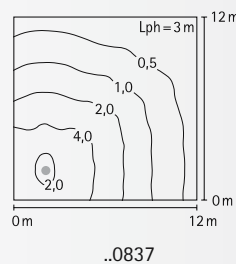

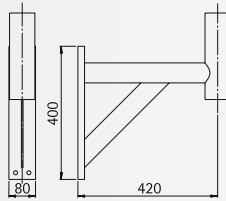

..1008

Pole top lamps

Protection class IP 54
 for fluorescent lamps TC-L
 for pole top $\varnothing = 76$ mm, pole type A
 or for installation with the bracket
 ..1008
 cast aluminium, reflector made of
 anodised pure aluminium
 clear impact resistant plexiglass

- Available on request for further lamps.

■ slant roof with upper light output

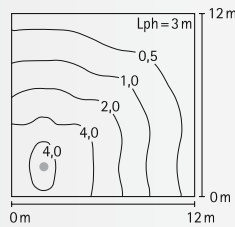
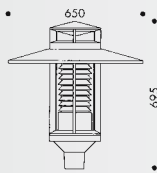

..0813

Art.-no.	Lamp	Base	Colour	
1-unit				
660813	2x TC-L 24 W	2G11	black	
2-units				
660814	4x TC-L 24 W	2G11	black	
3-units				
660815	6x TC-L 24 W	2G11	black	

■ slant roof with flat apex

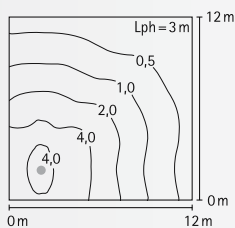
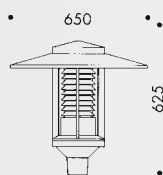

..0810

Art.-no.	Lamp	Base	Colour	
1-unit				
660810	2x TC-L 24 W	2G11	black	
2-units				
660811	4x TC-L 24 W	2G11	black	
3-units				
660812	6x TC-L 24 W	2G11	black	



Bollard lamp

Protection class IP 54
for fluorescent lamps TC-L
cast aluminium, reflector made of
anodised pure aluminium
clear impact resistant plexiglass

For installation on a foundation or
on the sunk pedestal 690010.

Art.-no.	Lamp	Base	Colour
Bollard lamp			
662204	1 x TC-L 24 W	2G11	black

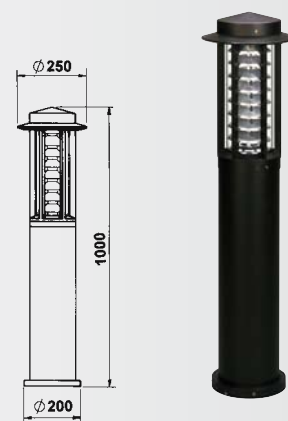
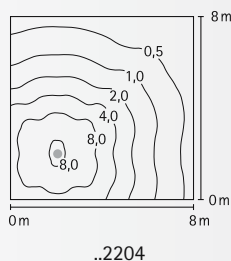

Pole lamp

Protection class IP 54
for fluorescent lamps TC-L
cast aluminium
with pole
reflector made of anodised pure
aluminium
clear impact resistant plexiglass

For installation on a foundation or
on the sunk pedestal 690011.

- slant roof with upper light output

Art.-no.	Lamp	Base	Colour
Pole lamp			
660862	1 x TC-L 24 W	2G11	black

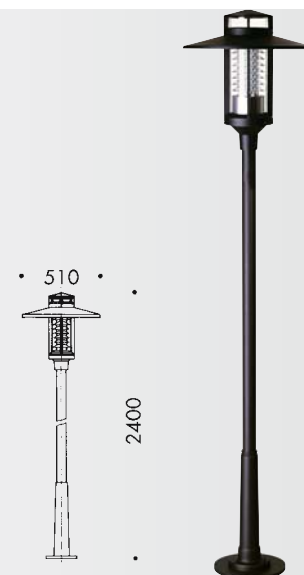
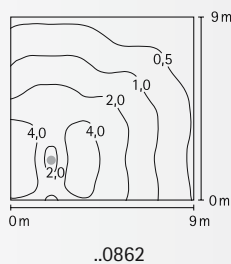

Object lamps

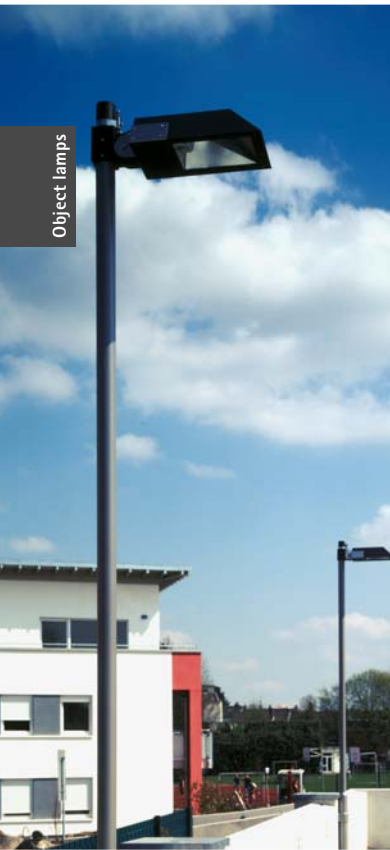

Vario II Wall and Pole top lamps

sleuable

Protection class IP 65
for high pressure discharged lamps
HIT/HME/HSE
respectively fluorescent lamps TC-TEL
for pole top $\varnothing = 76$ mm, pole type A
or installation on a wall
sleuable 0° to 45° in 15° -steps
cast aluminium and stainless steel
reflector made of anodised pure
aluminium
safety glass

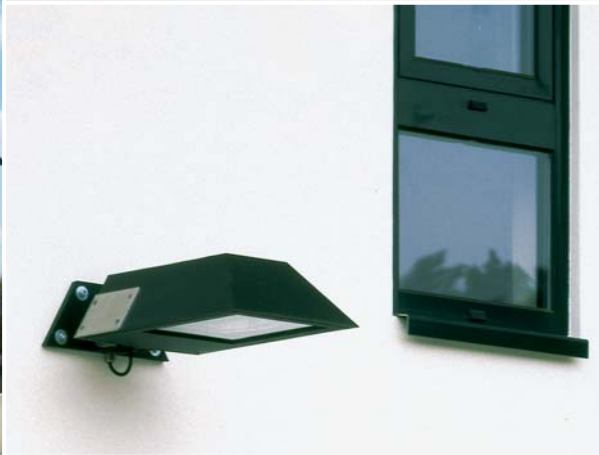

- A corner plate is available on request for the wall lamp.

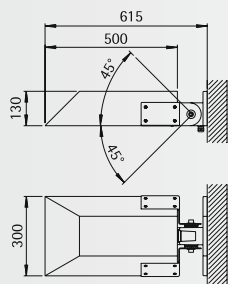

Wall lamps

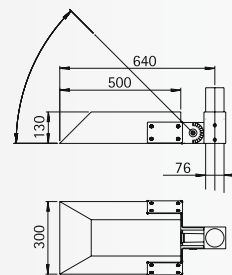

1-unit

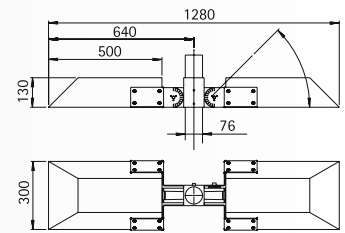

2-units

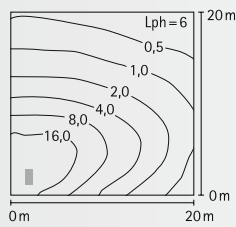

..0890

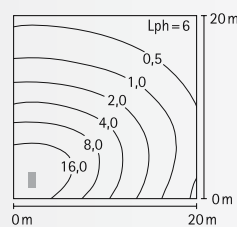

..0891

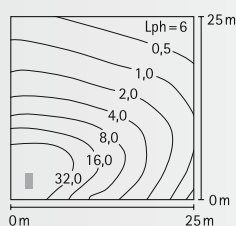

..0892

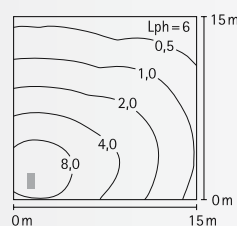

..0893

Art.-no.	Lamp	Base	Colour
Street lamps			
Wall lamps			
660302	1 x HST-MF/HIT-CE 70 W	E27	black
660303	1 x HME 80/125 W	E27	black
660304	1 x HST/HIT-CE 150 W	E40	black
660305	1 x TC-TEL 42 W	GX24q-4	black
1-unit			
660890	1 x HST-MF/HIT-CE 70 W	E27	black
660891	1 x HME 80/125 W	E27	black
660892	1 x HST/HIT-CE 150 W	E40	black
660893	1 x TC-TEL 42 W	GX24q-4	black
2-units			
660896	2 x HST-MF/HIT-CE 70 W	E27	black
660897	2 x HME 80/125 W	E27	black
660898	2 x HST/HIT-CE 150 W	E40	black
660899	2 x TC-TEL 42 W	GX24q-4	black



Object lamps

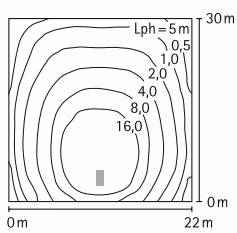

..0894

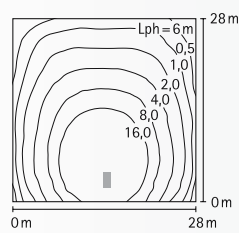

..0895

Art.-no.	Lamp	Base	Colour
Floodlights			
Wall lamps			
660306	1 x HIT-DE/HST-DE 70 W	RX7s	black
660307	1 x HIT-DE/HST-DE 150 W	RX7s	black
1-unit			
660894	1 x HIT-DE/HST-DE 70 W	RX7s	black
660895	1 x HIT-DE/HST-DE 150 W	RX7s	black
2-units			
660300	2 x HIT-DE/HST-DE 70 W	RX7s	black
660301	2 x HIT-DE/HST-DE 150 W	RX7s	black

Object lamps

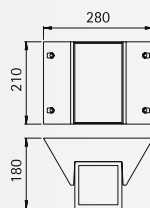
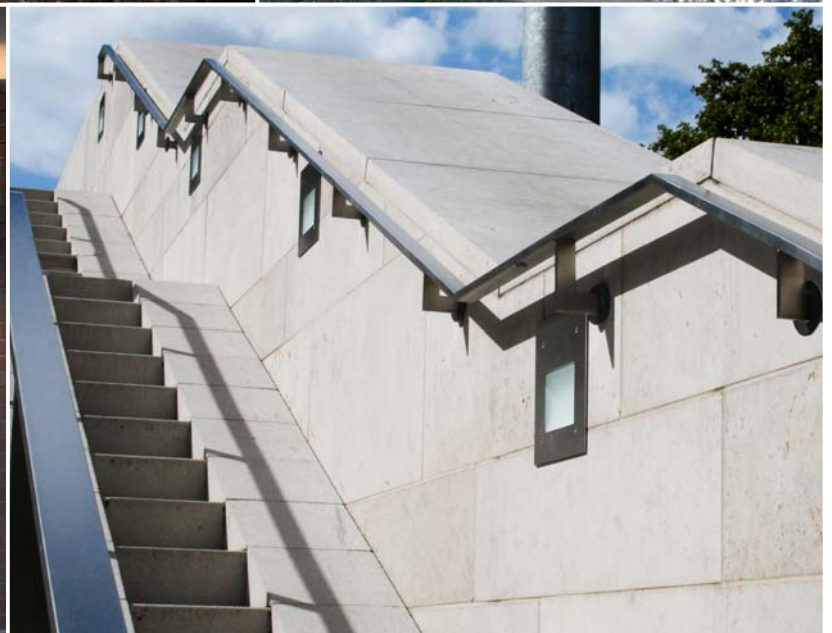

..0236

Wall spotlights

with double-sided
light output

Protection class IP 44
metal halide lamps HIT-TC-CE
stainless steel and cast aluminium
with mounting plate
borosilicate glass clear

Art.-no.	Lamp	Base	Material/Colour
620236	1 x HIT-TC-CE 35 W	G8,5	stainless steel / anthracite

Wall recessed floodlight

Protection class IP 44
 for metal halide lamps HIT-TC-CE
 respectively fluorescent lamps TC-TEL
 stainless steel
 reflector made of anodised pure aluminium
 borosilicate glass
 insert hole:
 ..0262 182 x 182 x 85 mm
 ..0264 270 x 270 x 105 mm

..0264 with electronic ballast

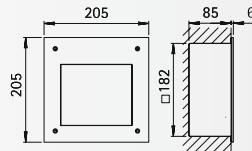

..0262

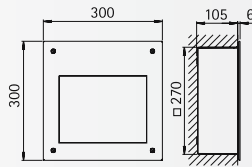

..0264

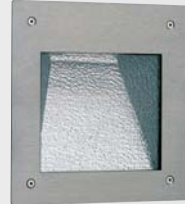

Art.-no.	Lamp	Base	Material
690262	1 x HIT-TC-CE 35 W	G8,5	stainless steel
690264	1 x TC-TEL 32 W	GX24q-3	stainless steel

Bollard floodlight

Protection class IP 44
 for metal halide lamps HIT-TC-CE
 with electronic ballast
 aluminium and stainless steel
 reflector made of anodised pure aluminium
 patterned safety glass

For installation on a foundation or on the sunk pedestal 690011

- Available on request for tungsten halogen lamps

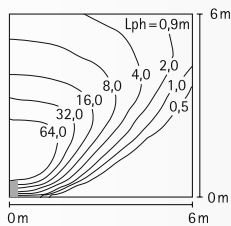

..0262, ..2271

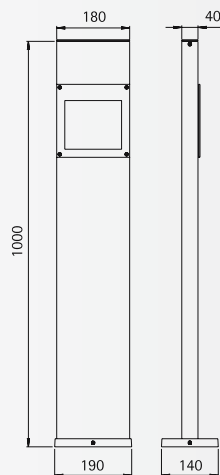

..2271



Art.-no.	Lamp	Base	Material / Colour
622271	1 x HIT-TC-CE 35 W	G8,5	stainless steel / anthracite



Light Sail

sleuable

Protection class IP 65
 for metal halide lamps HIT-DE,
 high pressure mercury lamps HME,
 high pressure sodium lamps HST-DE or
 for fluorescent lamps TC-L
 only for special poles **type B**
 height: 5000 - 8000 mm
 with pole top $\varnothing = 76$ mm
 cast aluminium and stainless steel, reflector
 made of anodised pure aluminium
 safety glass

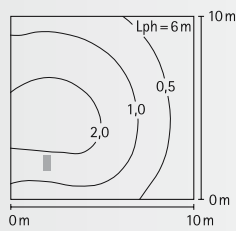
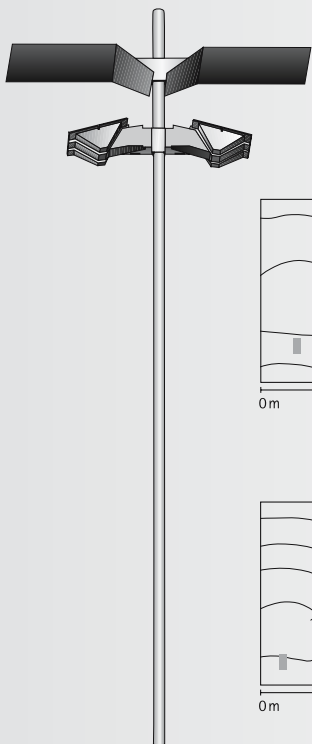
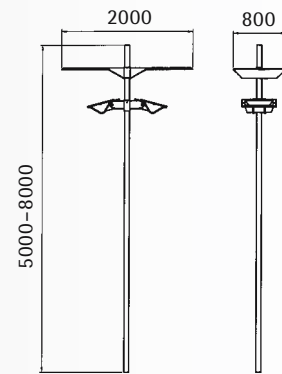
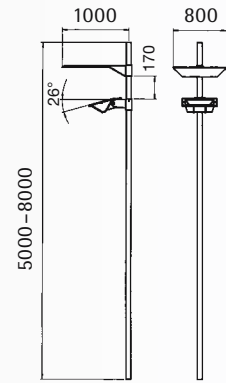

..0886

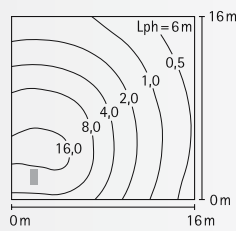

..0887

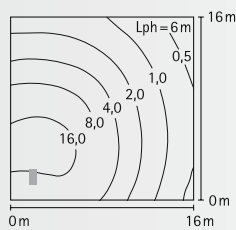

..0888

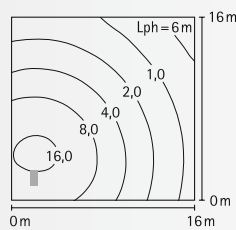

..0889

Art.-no.	Lamp	Base	Colour
1-unit			
660887	1 x HIT-DE 250 W	Fc 2	black
660888	1 x HST-DE 250 W	Fc 2	black
660889	1 x HME 250 W	E40	black
660886	2 x TC-L 24 W	2G11	black
2-units			
660883	2 x HIT-DE 250 W	Fc 2	black
660884	2 x HST-DE 250 W	Fc 2	black
660885	2 x HME 250 W	E40	black
660882	4 x TC-L 24 W	2G11	black

Vario-Floodlights

sleuable

Protection class IP 65
 for metal halide lamps HIT-DE,
 high pressure mercury lamps HME,
 high pressure sodium lamps HST-DE or
 for fluorescent lamps TC-L
 for pole top $\varnothing = 76$ mm, pole type A
 or mounting on a wall
 cast aluminium and stainless steel, reflector
 made of anodised pure aluminium
 safety glass

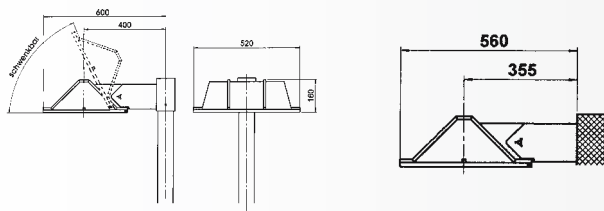

1-unit

Wall lamps

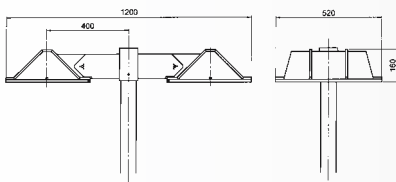

2-units

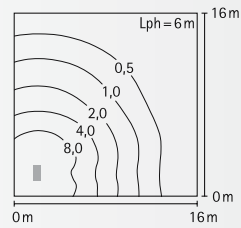

..0870

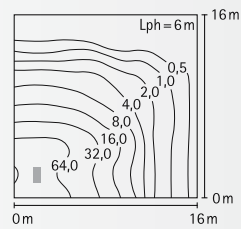

..0871

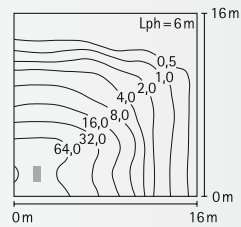

..0872

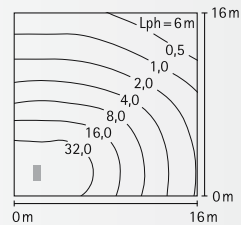

..0873



660874



660875



Ausieger-Sonderanfertigung

Art.-no.	Lamp	Base	Colour
Wall lamps			
660871	1 x HIT-DE 250 W	Fc2	black
660872	1 x HST-DE 250 W	Fc2	black
660873	1 x HME 250 W	E40	black
660870	2 x TC-L 24 W	2G11	black
1-unit			
660875	1 x HIT-DE 250 W	Fc2	black
660876	1 x HST-DE 250 W	Fc2	black
660877	1 x HME 250 W	E40	black
660874	2 x TC-L 24 W	2G11	black
2-units			
660879	2 x HIT-DE 250 W	Fc2	black
660880	2 x HST-DE 250 W	Fc2	black
660881	2 x HME 250 W	E40	black
660878	4 x TC-L 24 W	2G11	black

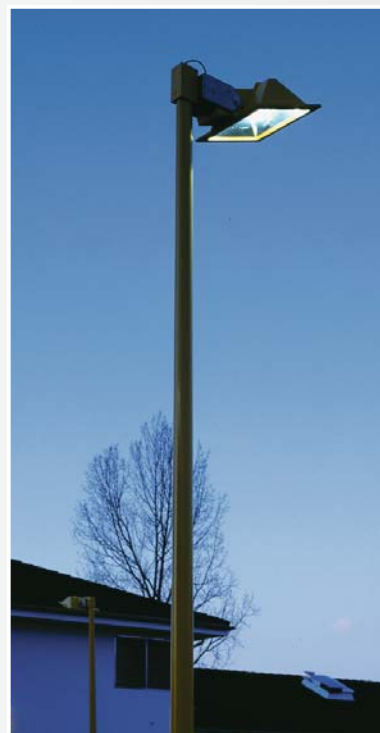

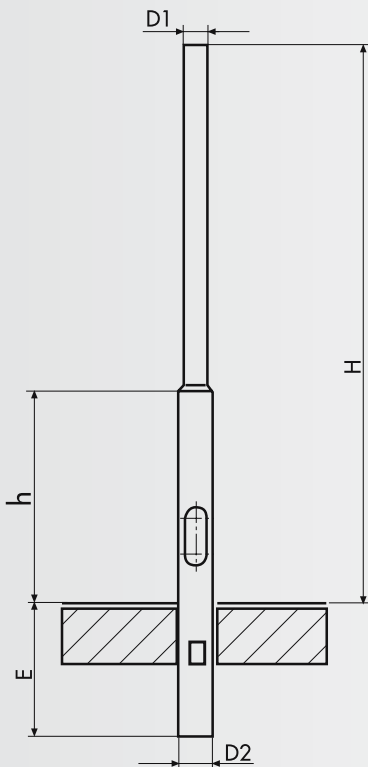
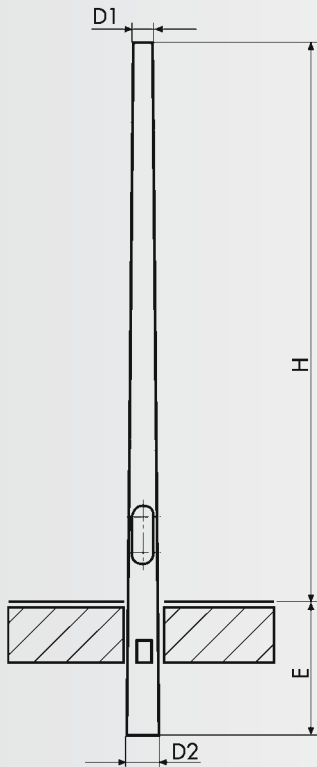

Poles made of steel

Height: 3000 – 8000 mm

pole top $\varnothing = 76$ mm

A For pole top lamps and Vario-spotlights

steel, hot dip galvanized, varnished respectively unvarnished

tapered respectively cylindrical stepped with ground unit

B Special poles for Light Sails

Because of special drill holes please use for Light Sails only poles type B!

Art.-no.	H	D1	D2	E	h
A tapered, with ground unit					
steel, hot-dip galvanized					
690018	3000	76	124	700	
690019	3500	76	124	700	
690040	4000	76	124	800	
690041	4500	76	130	800	
690042	5000	76	134	800	
690043	6000	76	151	1000	
steel, hot-dip galvanized and varnished					
690020	3000	76	124	700	
690021	3500	76	124	700	
690046	4000	76	124	800	
690047	4500	76	130	800	
690048	5000	76	134	800	
690049	6000	76	151	1000	

A cylindrical stepped, with ground unit

steel, hot-dip galvanized

690022	3000	76	114	700	900
690023	3500	76	114	700	900
690060	4000	76	114	800	1100
690061	4500	76	114	800	1200
690062	5000	76	114	800	1400
690063	6000	76	114	1000	2000
690064	7000	76	114	1000	2000
690065	8000	76	114	1000	2500
steel, hot-dip galvanized and varnished					
690024	3000	76	114	700	900
690025	3500	76	114	700	900
690066	4000	76	114	800	1100
690067	4500	76	114	800	1200
690068	5000	76	114	800	1400
690069	6000	76	114	1000	2000
690070	7000	76	114	1000	2000
690071	8000	76	114	1000	2500

B cylindrical stepped, with ground unit

steel, hot-dip galvanized

690100	5000	76	114	800	1500
690101	6000	76	114	1000	1500
690102	7000	76	114	1000	1500
690103	8000	76	114	1000	2000
steel, hot-dip galvanized and varnished					
690104	5000	76	114	800	1500
690105	6000	76	114	1000	1500
690106	7000	76	114	1000	1500
690107	8000	76	114	1000	2000

Junction box for all poles

690036